

TL50



Complete 50 mm LED Tower Light Family

Give machines a voice, provide critical information for operators and show process status

- Quickly and clearly discern ON and OFF states from across the factory
- Create your ideal hardware configuration from a full set of options
- Show advanced process details with multicolor RGB IO-Link® models



Your Best Design — Built by Banner



Standard models for traditional applications



Beacon models for use in high ambient light environments



Compact models for tight spaces and added intensity

Bright segments visible from long distances

Pro models available in all styles with 1 to 10 segments, plus audible options



Lights appear gray when OFF, eliminating false indication

Continuous, pulsed and staccato tones available



Standard Audible (IP50)
max. intensity
92 db @ 1 meter



Sealed Audible (IP67)
max. intensity
94 db @ 1 meter



Sealed Omni-Directional Audible (IP67)
Standard: max. intensity
99 db @ 1 meter
Intensity Adjust: max. intensity
95 db @ 1 meter

IP67 housing for use in industrial and outdoor environments

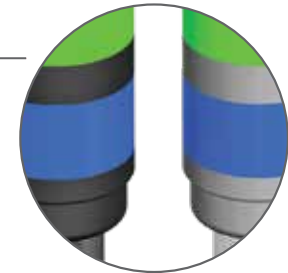

Match your machine with a choice of black or gray housing

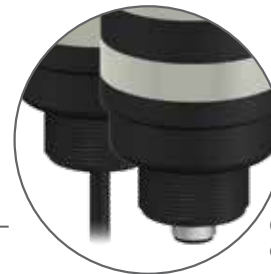

Cable, QD and pigtail QD connections available



Banner's Complete Tower Light Lineup



TL70
Modular 70 mm design provides solutions with wireless options, multicolor segments and multifunction audible segments

TL50
Sealed 50 mm design with advanced IO-Link functionality and three segment styles delivers versatility for all applications

TL30
Slim 30 mm design provides clear, comfortable light for small machines, dense and close-range installations

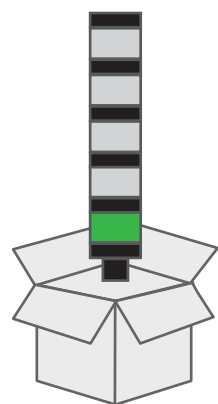

Ready to use right out of the box

DC 
AC 

Multiple input power options

 **IO-Link®**



IO-Link and discrete control options



Light segments can be laser marked with custom text or images

TL50 Core Tower Lights

- Traditional option to deliver status info to operators and supervisors
- High brightness and compact models for long-range and tight installations
- Ten colors and up to seven segments provide extensive options
- IO-Link provides simple control of segment state and flash rate

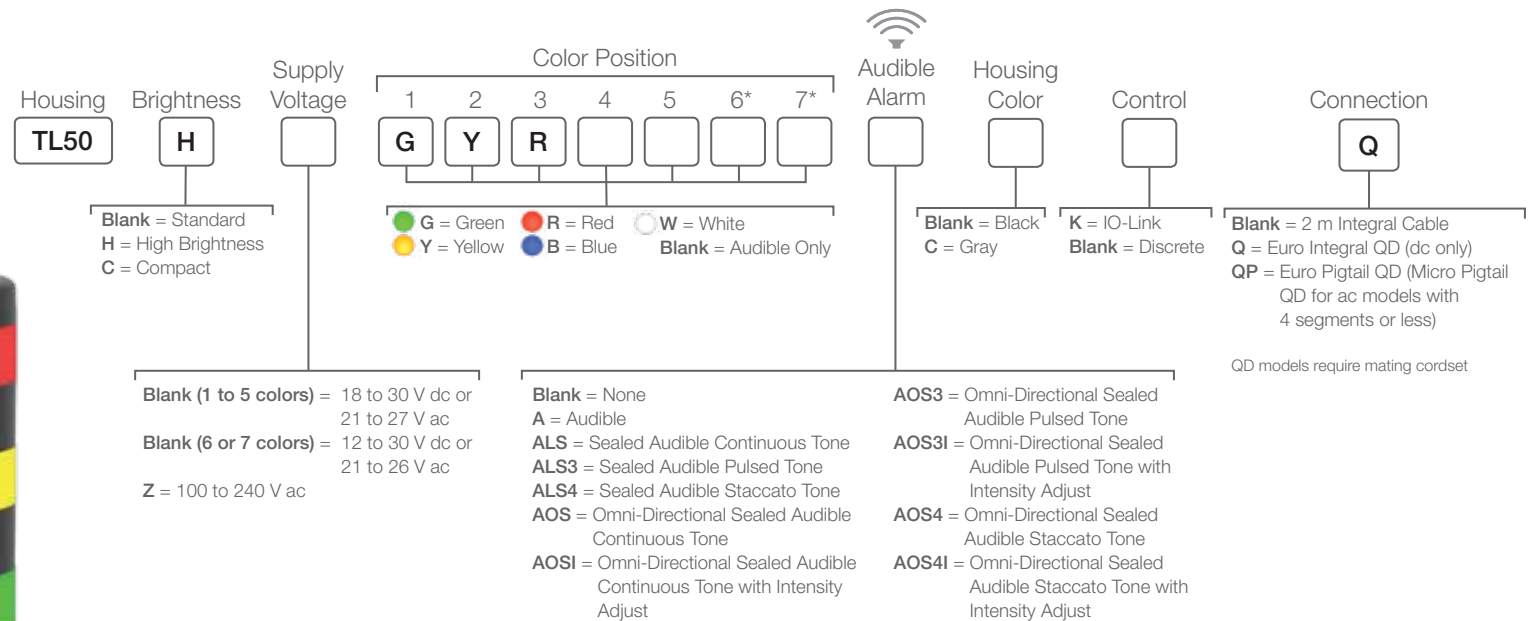

* Positions 6 and 7 not available in high brightness or AC models. Position 7 not available with audible

TL50BL Core Beacon Tower Lights

- Highly visible indication for high ambient light areas and long range visibility
- Sealed IP67-rated, UV stable housing is suitable for outdoor use
- Compact, stylish design with rotating and flashing options
- IO-Link provides control of segment state and flash rate

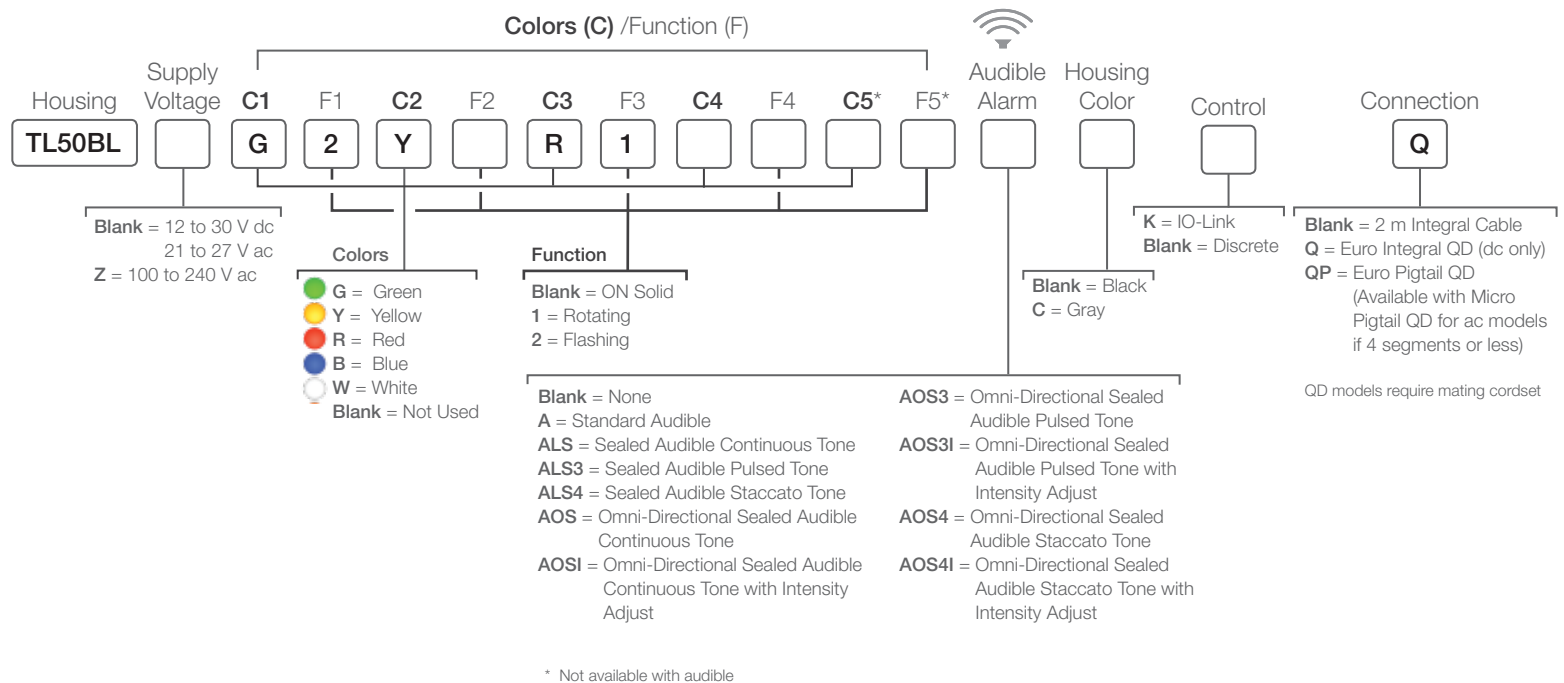

TL50 Pro Tower Lights with IO-Link

- Up to ten segments for advanced status signaling and high-resolution process details
- Full control of color, flashing, rotation and intensity settings
- Advanced animations like run and level mode provide dynamic visual response
- Parameter and process data options enable fast and complete control of functionality

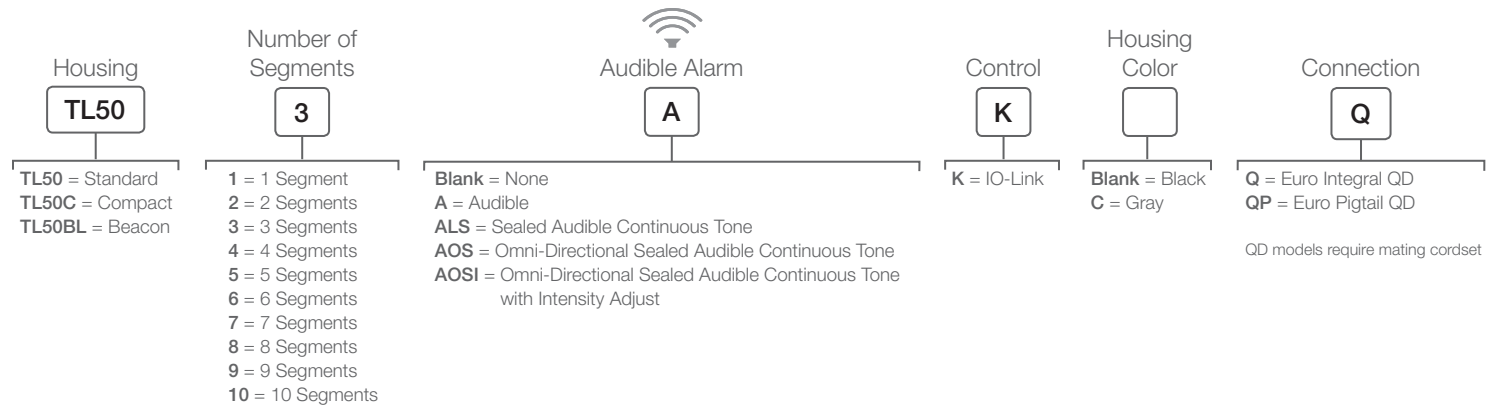

IO-Link®

5 Advantages of IO-Link

1. Standardized and Reduced Wiring
2. Increased Data Availability
3. Remote Configuration and Monitoring
4. Simple Device Replacement
5. Extended Diagnostics

Fill Level Monitoring

Challenge

- Operators, material handlers and supervisors need to see the level of product in the hopper
- Local displays aren't visible from separate, distant locations in the factory
- Product overflow creates a mess, and an empty hopper stops production

Solution

- The TL50 Pro tower light shows fill level through distinct, color-coded segments, and is visible from across the factory floor
- The IO-Link master directly converts the laser measurement into an easy to understand fill level based on user defined thresholds
- Product level is optimized for daily production needs



Modes and Animations

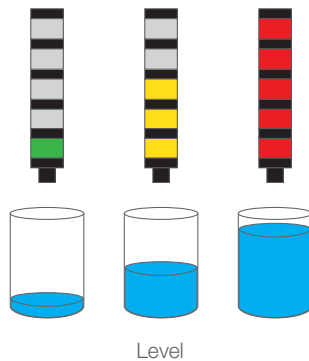

Spectrum



50/50



Rotate



Strobe



Scroll



Flash



Bounce

Elevated Mount System

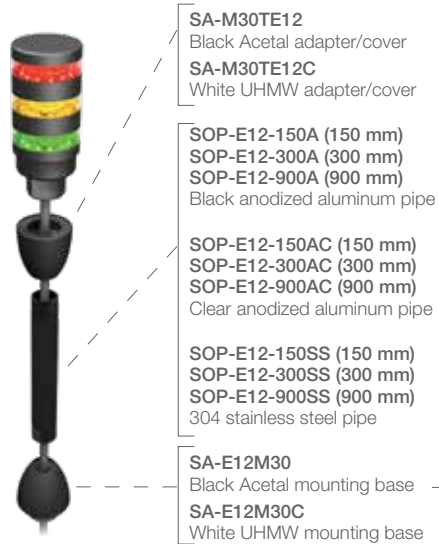

Flush Foldable Bracket for use with elevated mount systems



Supply Voltage	TL50 and TL50C: < 5 segments: 18 to 30 V dc or 21 to 27 V ac; 100 to 240 V ac > 5 segments: 12 to 30 V dc or 21 to 26 V ac TL50BL: 12 to 30 V dc or 21 to 27 V ac; 100 to 240 V ac IO-Link: 18 to 30 V dc
Construction	Bases and Covers: ABS Light Segment: Polycarbonate
Environmental Rating	General-Purpose and Sealed Audible: IEC IP67 Standard Audible: IEC IP50
Operating Temperature	General-Purpose: -40 to +50 °C (-40 to +122 °F) Standard and Sealed Audible: -20 to +50 °C (-4 to +122 °F)
Certifications	CE ULS LISTED

Mounting Brackets



Sealed Right-Angle Brackets



Cordsets for AC Models

4-Pin Micro-Style
Straight connector models listed;
for right-angle models, add RA
to the end of model number
(example, MQAC2-406RA)

5-Pin Micro-Style
Straight connector models

MQAC2-406
2 m (6.5')
MQAC2-415
5 m (15')
MQAC2-430
9 m (30')

MQAC2-506
2 m (6.5')
MQAC2-515
5 m (15')
MQAC2-530
9 m (30')

Cordsets for DC Models

4-Pin M12/Euro-Style
use with 3-color and IO-Link models
Straight connector models listed;
for right-angle models, add RA to the end of
model number (example, MQDC-406RA)

5-Pin M12/Euro-Style
use with 4-color models

Straight connector models listed;
for right-angle models, add RA to
the end of model number
(example, MQDC1-506RA)

8-Pin M12/Euro-Style
use with 5+ -color models

Straight connector models listed;
for right-angle models, add RA to
the end of model number (example,
MQDC2S-806RA)

MQDC-406
2 m (6.5')
MQDC-415
5 m (15')
MQDC-430
9 m (30')

MQDC1-506
2 m (6.5')
MQDC1-515
5 m (15')
MQDC1-530
9 m (30')

MQDC2S-806
2 m (6.5')
MQDC2S-815
5 m (15')
MQDC2S-830
9 m (30')

