

System overview

1 Chain bracket

Chain bracket angle

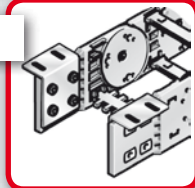

Chain bracket U-part

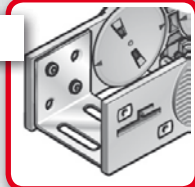

2 Shelving system

Separator TR



H-shaped shelf unit RE

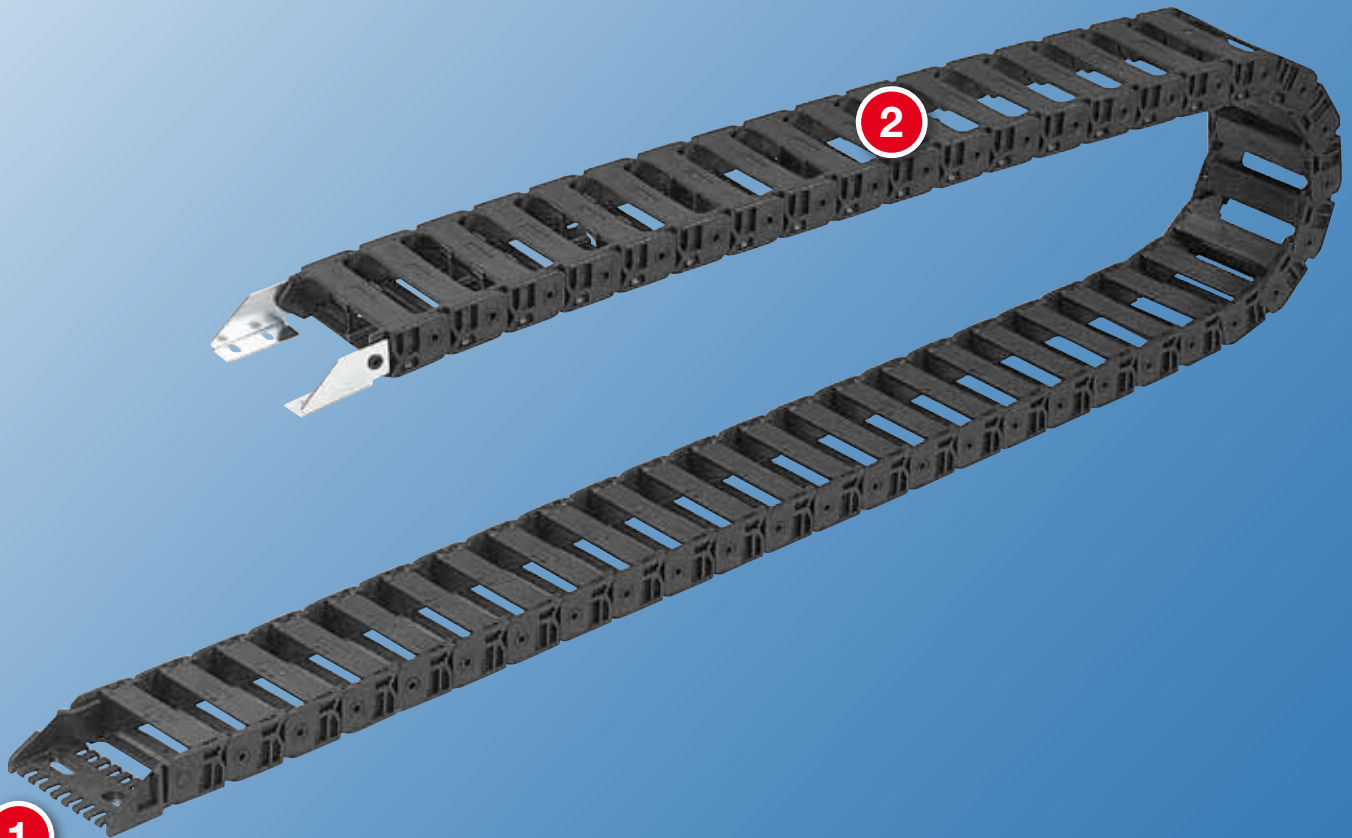

Guide channels

Aluminium VAW

Plastic VWAK

Stainless steel VAW-E



Technical data

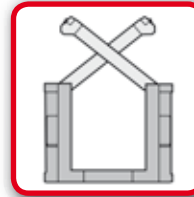

Loading side

Inside bend

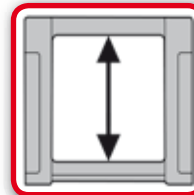

Available interior heights

26.0 mm

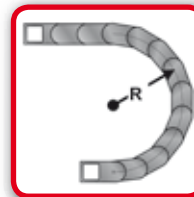

Available radii

50.0 – 300.0 mm

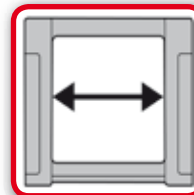

Available interior widths

26.0 – 125.0 mm

Ordering key

Type	Variation	Dimensions			Ridge version		Chain length mm
		Inside width mm	Outside width mm	Radius mm		Material	
0300	02	26 37 56 62 76 87 101 125	44 55 74 80 94 105 119 143	50 70 95 120 150 200 300	0 1	0 1 5 7 9	
Ordering key		[][][]	[][][]	[][][]	[][]	[][][][][]	



Chain link

Loading side:

Inside bend

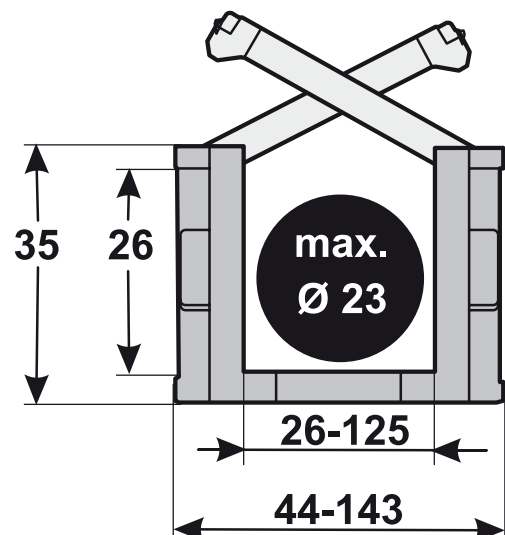

Dimensions in mm

- 0 Standard (PA/black)
- 1 UL94/V0 (PA/oxide red)
- 5 Polypropylene (PP/blue)
- 7 EMC (PA/light grey)
- 9 Special version

- 0 PA full-ridged with bias
- 1 PA full-ridged without bias

- 02 Frame bridge on outside of radius
- Frame bridge on inside of radius
- Opens on inside of radius

Order sample: 0300 02 026 050 0 0 1215

Frame bridge in outside bend, frame bridge in inside bend, can be opened from inside bend
 Inside width 26 mm; radius 50 mm
 Plastic bridge, full-ridged with bias, material black-coloured polyamide
 Chain length 1215 mm (27 links)

Technical specifications

Travel distance gliding L_g max.:	60.0 m
Travel distance self-supporting L_f max.:	see diagram
Travel distance vertical, hanging L_{vh} max.:	40.0 m
Travel distance vertical, upright L_{vs} max.:	3.0 m
Rotated 90°, unsupported L_{90f} max.:	0.7 m
Speed, gliding V_g max.:	3.0 m/s
Speed, self-supporting V_f max.:	6.0 m/s
Acceleration, gliding a_g max.:	10.0 m/s ²
Acceleration, self-supporting a_f max.:	15.0 m/s ²

Material properties

Standard material:	Polyamide (PA) black
Service temperature:	-30.0 – 120.0 °C
Gliding friction factor:	0.3
Static friction factor:	0.45
Fire classification:	UL 94 HB
Other material properties on request.	

Determining the chain length

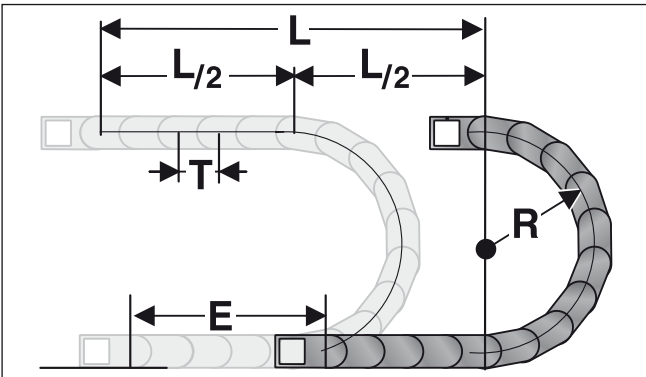

The fixed point of the cable drag chain should be connected in the middle of the travel distance. This arrangement gives the shortest connection between the fixed point and the moving consumer and thus the most efficient chain length.

$$\text{Chain length calculation} = L/2 + \pi * R + 2 * T + E$$

≈ 1 m chain = x 45.0 mm links.

E = distance between entry point and middle of travel distance
L = travel distance
R = radius
P = Pitch

Self-supporting length

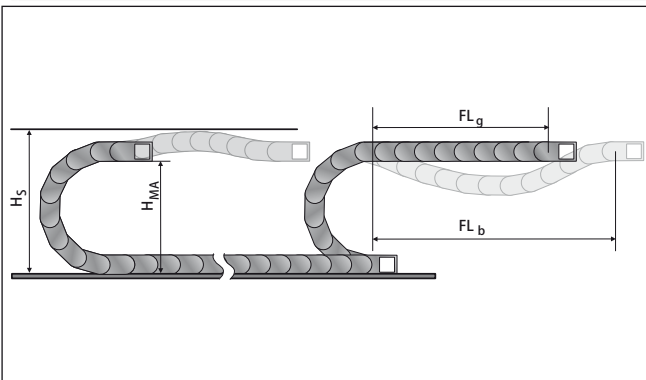

The self-supporting length is the distance between the chain bracket on the moving end and the start of the chain arch.

The installation variant FL_g offers the lowest load and wear for the cable drag chain.

The maximum travel parameters (speed and acceleration) can be applied for this variant.

H_s = Installation height plus safety
 H_{MA} = Height of moving end connection
 FL_g = Self-supporting length, upper run straight
 FL_b = Self-supporting length, upper run bent

Load diagram for self-supporting applications

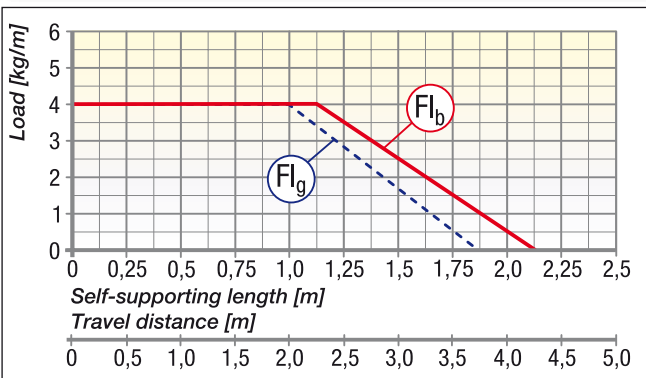

FL_g Self-supporting Length, upper run straight
In the FL_g range, the chain upper run still has a bias, is straight or has a maximum sag of

FL_b Self-supporting Length, upper run bent
In the FL_b range, the chain upper run has a sag of more than , but this is still less than the maximum sag. Where the sag is greater than that permitted in the FL_b range, the application is critical and should be avoided. The self-supporting length can be optimized by using a support for the upper run or a more stable cable drag chain.

Installation dimensions

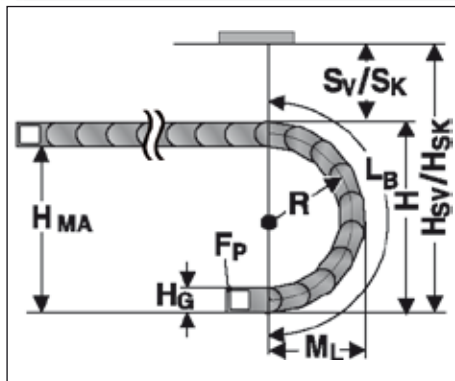

Radius R	50	70	95	120	150	200	300
Outside height of chain link (H_v)	35	35	35	35	35	35	35
Height of bend (H)	135	175	225	275	335	435	635
Height of moving end connection (H_{MA})	100	140	190	240	300	400	600
Safety margin with bias (S_v)	45	45	45	45	45	45	45
Installation height with bias (H_{SV})	180	220	270	320	380	480	680
Safety margin without bias (S_K)	10	10	10	10	10	10	10
Installation height without bias (H_{SK})	145	185	235	285	345	445	645
Arc projection (M_L)	113	133	158	183	213	263	363
Bend length (L_b)	257	320	398	477	571	728	1042

Chain bracket angle

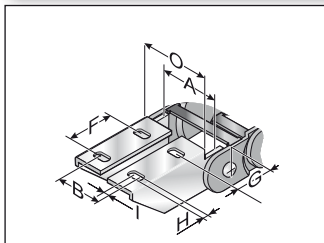

KA 300... (Inside up / down)

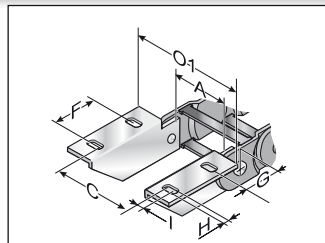

KA 300... (Outside up / down)

The chain bracket can be supplied either in galvanised sheet steel or stainless steel. To secure one cable drag chain, you will need two angle brackets (left and right) with a drilled hole and two angle brackets (left and right) with a bolt. The order numbers given below each comprise a left and right angle bracket.

Type	Order no.	Material	Inside width							Outside width KA	Outside width KA
			A	B	C	F	G	HØ	I		
			mm	mm	mm	mm	mm	mm	mm	mm	mm
KA 3008 male	0300000052	Sheet steel	26.0 – 125.0	A-8.5	A+22.5	25.0	21.0	6.5	45.0	A+18.0	A+40.0
KA 3008 female	0300000053	Sheet steel	26.0 – 125.0	A-3.5	A+31.0	25.0	21.0	6.5	45.0	A+9.0	A+40.0
KA 3009 male	0300000054	Stainless steel 1.4301	26.0 – 125.0	A-8.5	A+22.5	25.0	21.0	6.5	45.0	A+18.0	A+40.0
KA 3009 female	0300000055	Stainless steel 1.4301	26.0 – 125.0	A-3.5	A+31.0	25.0	21.0	6.5	45.0	A+9.0	A+40.0

Chain bracket U-part

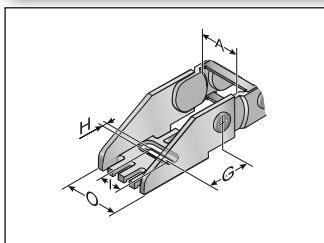

KA/Z 3001

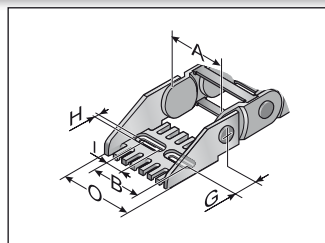

KA/Z 3002 – 3006

The type KA/Z 3001 – 3006 chain bracket is a plastic part with an extrusion-coated metal insert. The bracket is precisely adjusted to the respective chain width and only needs to be snapped in at the chain link. Please order one male and one female end bracket for each chain. The brackets should be fastened with M6 screws. The cables or tubes may be fastened with cable ties at the integrated strain relief of the chain bracket.

Type	Order no.	Material	Inside width					Outside width KA
			A	B	G	HØ	I	
			mm	mm	mm	mm	mm	
KA/Z 3001 male	030000008000	Plastic with metal insert	26.0		31.5	6.5	18.5	A+18.0
KA/Z 3001 female	030000008100	Plastic with metal insert	26.0		31.5	6.5	18.5	A+18.0
KA/Z 3002 male	030000008200	Plastic with metal insert	37.0	A-7.0	31.5	6.5	7.5	A+18.0
KA/Z 3002 female	030000008300	Plastic with metal insert	37.0	A-7.0	31.5	6.5	7.5	A+18.0
KA/Z 3002.5 male	030000007600	Plastic with metal insert	56.0	A-8.0	31.5	6.5	7.5	A+18.0
KA/Z 3002.5 female	030000007700	Plastic with metal insert	56.0	A-8.0	31.5	6.5	7.5	A+18.0
KA/Z 3003 male	030000008400	Plastic with metal insert	62.0	A-7.0	31.5	6.5	18.5	A+18.0



Chain bracket U-part (Continued...)

Type	Order no.	Material	Inside width					Outside width KA
			A mm	B mm	G mm	HØ mm	I mm	O mm
KA/Z 3003 female	030000008500	Plastic with metal insert	62.0	A-7.0	31.5	6.5	18.5	A+18.0
KA/Z 3003.5 male	030000007800	Plastic with metal insert	76.0	A-8.0	31.5	6.5	18.5	A+18.0
KA/Z 3003.5 female	030000007900	Plastic with metal insert	76.0	A-8.0	31.5	6.5	18.5	A+18.0
KA/Z 3004 male	030000008600	Plastic with metal insert	87.0	A-7.0	31.5	6.5	18.5	A+18.0
KA/Z 3004 female	030000008700	Plastic with metal insert	87.0	A-7.0	31.5	6.5	18.5	A+18.0
KA/Z 3005 male	030000008800	Plastic with metal insert	101.0	A-7.0	31.5	6.5	18.5	A+18.0
KA/Z 3005 female	030000008900	Plastic with metal insert	101.0	A-7.0	31.5	6.5	18.5	A+18.0
KA/Z 3006 male	030000009300	Plastic with metal insert	125.0	A-6.5	31.5	6.5	18.5	A+18.0
KA/Z 3006 female	030000009400	Plastic with metal insert	125.0	A-6.5	31.5	6.5	18.5	A+18.0

Shelving system

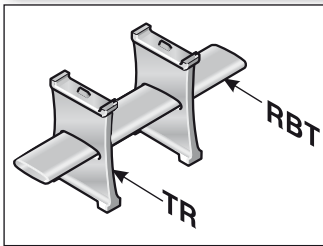

The shelf must be used with a minimum of two separators to create a shelving system. The additional levels prevent cables from criss-crossing and therefore destroying each other, while also avoiding excessive friction. The shelves are matched to the available chain widths.

Type	Order no.	Designation	Width mm	Pitch mm
RBT 037	100000003700	Shelf	37.0	3.0
RBT 062	100000006200	Shelf	62.0	3.0
RBT 086	100000008600	Shelf	86.0	3.0
RBT 101	100000010100	Shelf	101.0	3.0
RBT 125	100000012500	Shelf	125.0	3.0

Separator

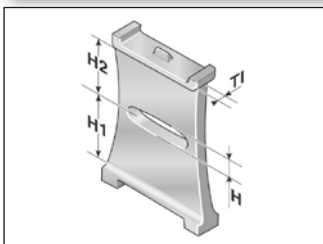

We recommend that separators be used if multiple round cables or conduits with differing diameters are to be installed. An offset configuration of the separators is advisable. The lockable separator must be used for side-mounted cable drag chains to prevent the separator from slipping down.

Separator

Type	Order no.	Designation	Version	Pitch mm	T1 mm	H mm	H1 mm	H2 mm
TR 3000	030000009000	Separator	moveable	3.0	1.5	2.5	12.9	12.9
TR 3001	030000009200	Separator	moveable / lockable	3.0	1.5	2.5	12.9	12.9
TR 3002	030000009500	Separator, closed	moveable / lockable	3.0	1.5	2.5	12.9	12.9

Shelf unit

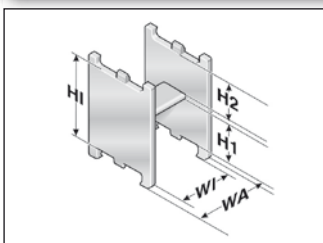

Insert to obtain additional levels in pre-defined window distances.

Shelf unit

Type	Order no.	Designation	Pitch mm	WA mm	WI mm	H1 mm	H2 mm	HI mm
RE 26/15	100000261510	H-shaped shelf unit	3.0	17.5	12.5	13.7	9.6	26.0
RE 26/27	100000262710	H-shaped shelf unit	3.0	29.5	24.5	13.7	9.6	26.0
RE 26/32	100000263210	H-shaped shelf unit	3.0	34.5	29.5	13.7	9.6	26.0
RE 26/51	100000265110	H-shaped shelf unit	3.0	53.5	48.5	13.7	9.6	26.0

Guide channels (VAW)



VAW-K

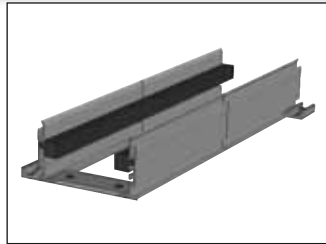

VAW



VAW-E

For this cable drag chain, a range of variable guide channel systems are available, constructed from aluminium, plastic or stainless steel sections.

The variable guide channel ensures that the cable drag chain is supported and guided securely.

For help on choosing, please consult the chapter „Variable Guide Channel System“.

Assembly

Disassembly

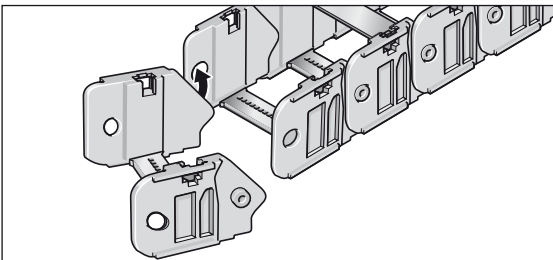

Step 1

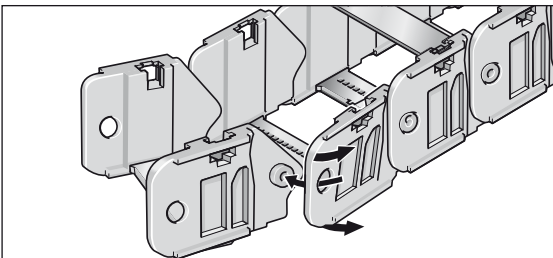

Step 2

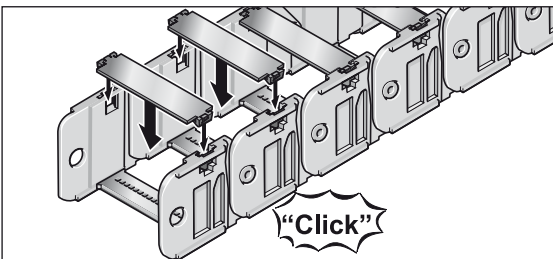

Step 3

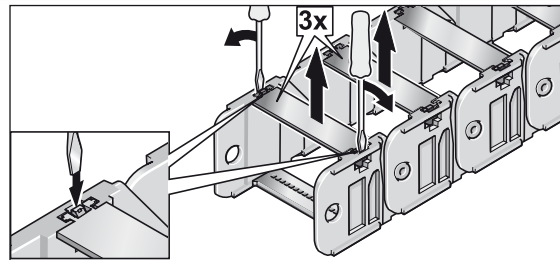

Step 1

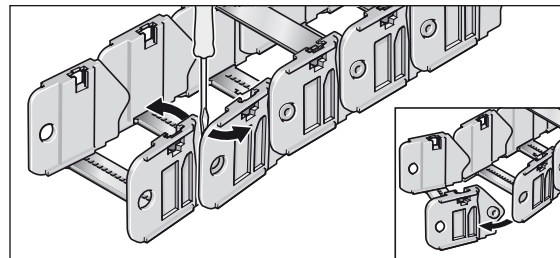

Step 2

